

Operating Systems (Honor Track)

Scheduling 1: Concepts and Classic Policies

Xin Jin

Spring 2024

Recap: Readers/Writers Problem

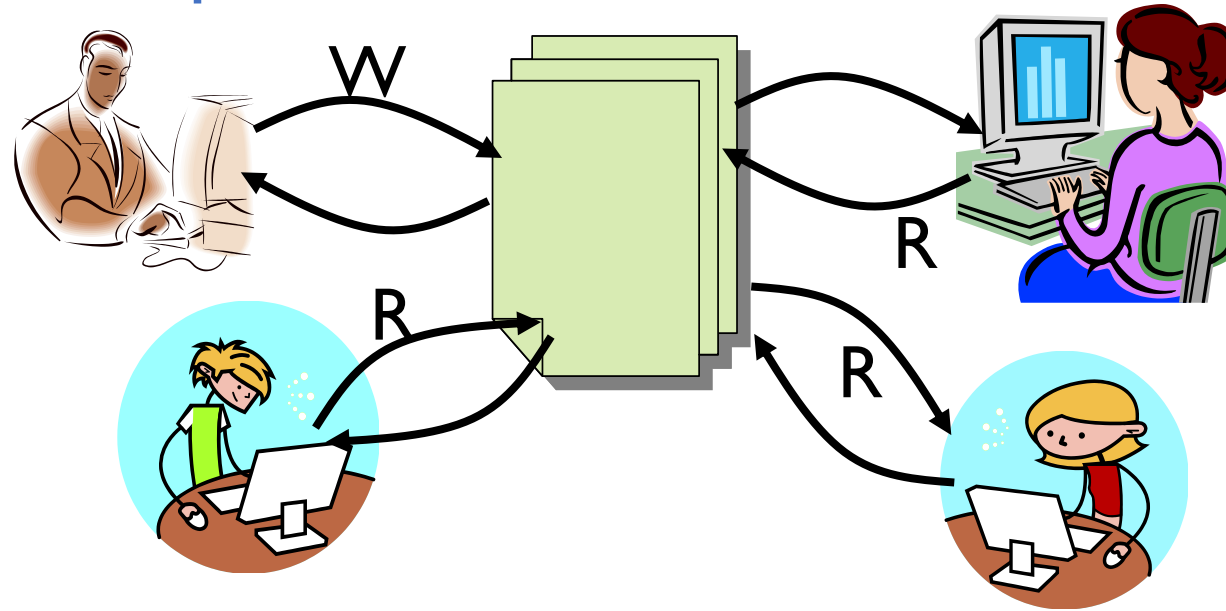

- Motivation: Consider a shared database
 - Two classes of users:
 - » Readers – never modify database
 - » Writers – read and modify database
 - Is using a single lock on the whole database sufficient?
 - » Like to have many readers at the same time
 - » Only one writer at a time

Recap: Basic Readers/Writers Solution

- Correctness Constraints:
 - Readers can access database when no writers
 - Writers can access database when no readers or writers
 - Only one thread manipulates state variables at a time
- Basic structure of a solution:
 - **Reader()**
 - Wait until no writers
 - Access database
 - Check out - wake up a waiting writer
 - **Writer()**
 - Wait until no active readers or writers
 - Access database
 - Check out - wake up waiting readers or writer
 - State variables (Protected by a lock called “lock”):
 - » int AR: Number of active readers; initially = 0
 - » int WR: Number of waiting readers; initially = 0
 - » int AW: Number of active writers; initially = 0
 - » int WW: Number of waiting writers; initially = 0
 - » Condition okToRead = NIL
 - » Condition okToWrite = NIL

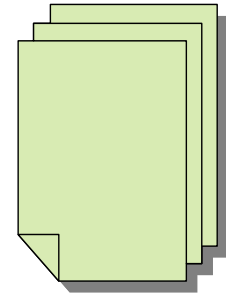

Recap: Code for a Reader

```
Reader() {
    // First check self into system
    acquire(&lock);
    while ((AW + WW) > 0) { // Is it safe to read?
        WR++;                // No. Writers exist
        cond_wait(&okToRead, &lock); // Sleep on cond var
        WR--;                // No longer waiting
    }
    AR++;                    // Now we are active!
    release(&lock);
    // Perform actual read-only access
    AccessDatabase(ReadOnly);
    // Now, check out of system
    acquire(&lock);
    AR--;                    // No longer active
    if (AR == 0 && WW > 0) // No other active readers
        cond_signal(&okToWrite); // Wake up one writer
    release(&lock);
}
```

Recap: Code for a Writer

```
Writer() {
    // First check self into system
    acquire(&lock);
    while ((AW + AR) > 0) { // Is it safe to write?
        WW++; // No. Active users exist
        cond_wait(&okToWrite, &lock); // Sleep on cond var
        WW--; // No longer waiting
    }
    AW++; // Now we are active!
    release(&lock);
    // Perform actual read/write access
    AccessDatabase(ReadWrite);
    // Now, check out of system
    acquire(&lock);
    AW--; // No longer active
    if (WW > 0) { // Give priority to writers
        cond_signal(&okToWrite); // Wake up one writer
    } else if (WR > 0) { // Otherwise, wake reader
        cond_broadcast(&okToRead); // Wake all readers
    }
    release(&lock);
}
```

Recap: Group Discussion

- Can readers starve? Consider Reader() entry code:

```
while ((AW + WW) > 0) { // Is it safe to read?
    WR++;                // No. Writers exist
    cond_wait(&okToRead, &lock); // Sleep on cond var
    WR--;                // No longer waiting
}
AR++;                  // Now we are active!
```

- What if we erase the condition check in Reader exit?

```
AR--;                // No longer active
if (AR == 0 && WW > 0) // No other active readers
    cond_signal(&okToWrite); // Wake up one writer
```

- Further, what if we turn the signal() into broadcast()

```
AR--;                // No longer active
cond_broadcast(&okToWrite); // Wake up sleepers
```

- Finally, what if we use only one condition variable (call it “**okContinue**”) instead of two separate ones?

- Both readers and writers sleep on this variable
- Must use broadcast() instead of signal()

Goal for Today

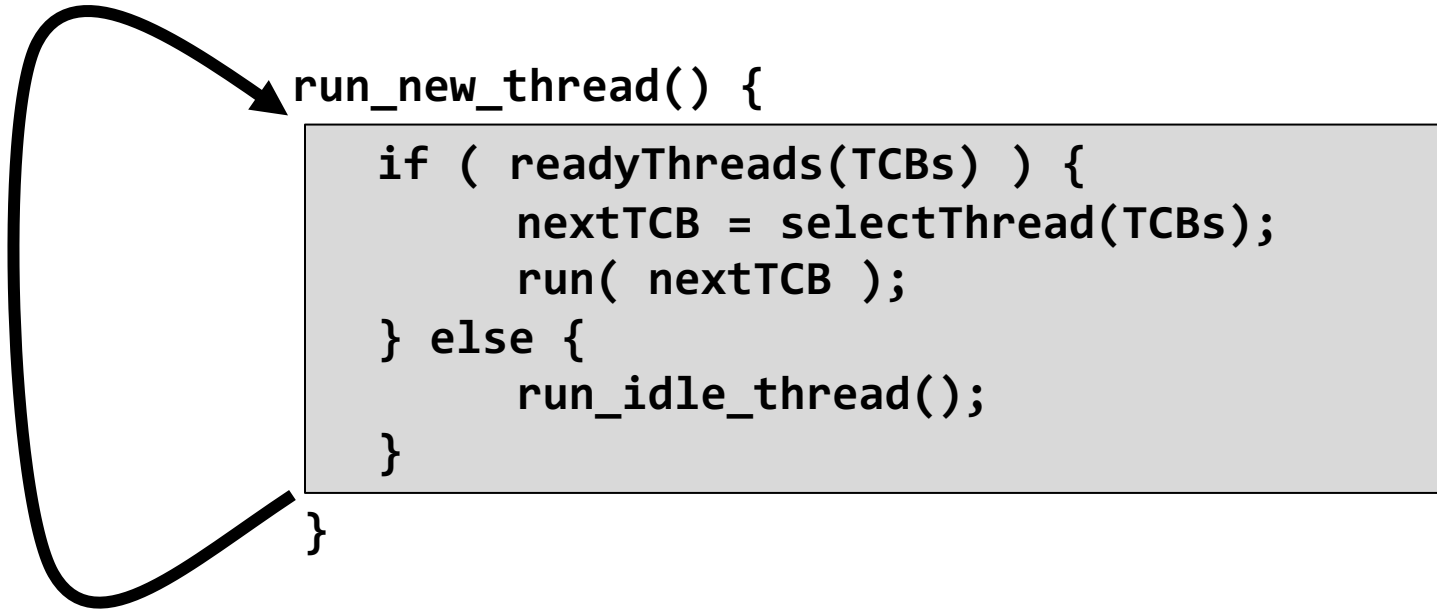

- Discussion of Scheduling:
 - Which thread should run on the CPU next?
- Scheduling goals, policies
- Look at a number of different schedulers

Scheduling: All About Queues



Scheduling Assumptions

- CPU scheduling big area of research in early 70's
- Many implicit assumptions for CPU scheduling:
 - One program per user
 - One thread per program
 - Programs are independent
- Clearly, these are unrealistic but they simplify the problem so it can be solved
 - For instance: is “fair” about fairness among users or programs?
 - » If I run one compilation job and you run five, you get five times as much CPU on many operating systems
- The high-level goal: Dole out CPU time to optimize some desired parameters of system



Assumption: CPU Bursts

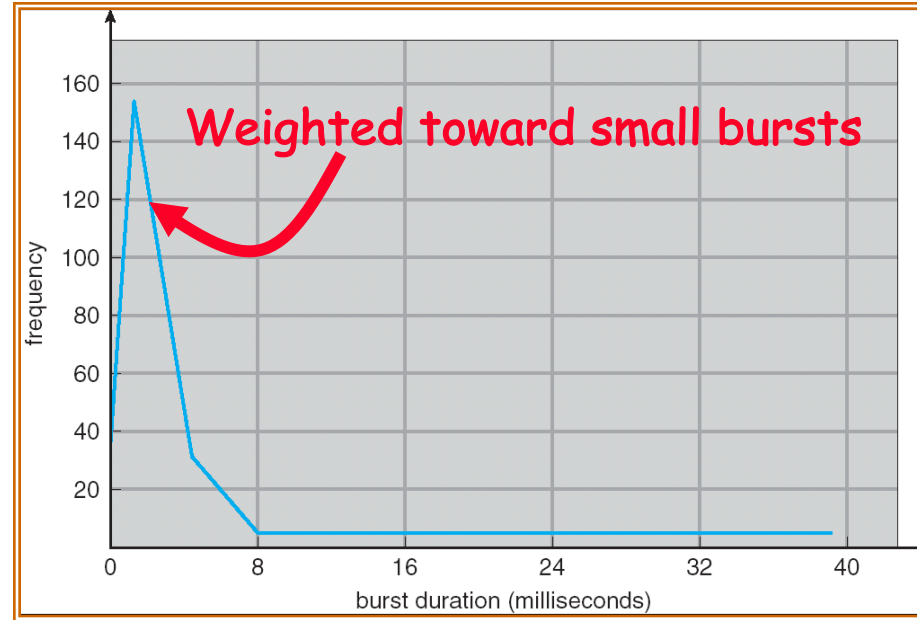
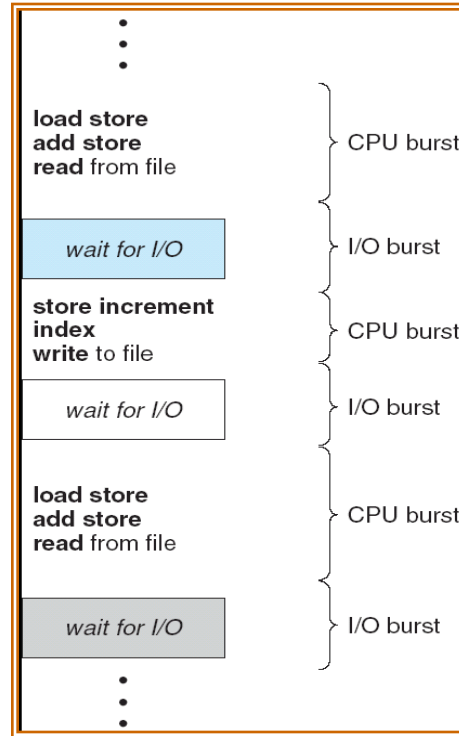

- Execution model: programs alternate between bursts of CPU and I/O
 - Program typically uses the CPU for some period of time, then does I/O, then uses CPU again
 - Each scheduling decision is about which job to give to the CPU for use by its next CPU burst
 - With time slicing, thread may be forced to give up CPU before finishing current CPU burst

Scheduling Policy Goals/Criteria

- Minimize Completion Time
 - Minimize elapsed time to do an operation (or job)
 - Completion time is what the user sees:
 - » Time to echo a keystroke in editor
 - » Time to compile a program
 - » Real-time Tasks: Must meet deadlines imposed by World
- Maximize Throughput
 - Maximize operations (or jobs) per second
 - Throughput related to completion time, but not identical:
 - » Minimizing completion time will lead to more context switching than if you only maximized throughput
 - Two parts to maximizing throughput
 - » Minimize overhead (for example, context-switching)
 - » Efficient use of resources (CPU, disk, memory, etc.)
- Fairness
 - Share CPU among users in some equitable way
 - Fairness is not minimizing average completion time:
 - » Better *average* completion time by making system *less* fair

First-Come, First-Served (FCFS) Scheduling

- First-Come, First-Served (FCFS)
 - Also “First In, First Out” (FIFO) or “Run until done”
 - » In early systems, FCFS meant one program scheduled until done (including I/O)
 - » Now, means keep CPU until thread blocks



- Example:

<u>Process</u>	<u>Burst Time</u>
P_1	24
P_2	3
P_3	3

- Suppose processes arrive in the order: P_1, P_2, P_3
The Gantt Chart for the schedule is:



- Waiting time for $P_1 = 0$; $P_2 = 24$; $P_3 = 27$
- Average waiting time: $(0 + 24 + 27)/3 = 17$
- Average completion time: $(24 + 27 + 30)/3 = 27$
- **Head-of-line blocking:** short process stuck behind long process

FCFS Scheduling (Cont.)

- Example continued:
 - Suppose that processes arrive in order: P2 , P3 , P1
Now, the Gantt chart for the schedule is:



- Waiting time for P1 = 6; P2 = 0; P3 = 3
 - Average waiting time: $(6 + 0 + 3)/3 = 3$
 - Average Completion time: $(3 + 6 + 30)/3 = 13$
- In second case:
 - Average waiting time is much better (before it was 17)
 - Average completion time is better (before it was 27)
- FIFO Pros and Cons:
 - Simple (+)
 - Head-of-line blocking: Short jobs get stuck behind long ones (-)
 - » Safeway: Getting milk, always stuck behind cart full of items!
Upside: get to read about Space Aliens!

Round Robin (RR) Scheduling

- FCFS Scheme: Potentially bad for short jobs!
 - Depends on submit order
 - If you are first in line at supermarket with milk, you don't care who is behind you, on the other hand...
- Round Robin Scheme: **Preemption!**
 - Each process gets a small unit of CPU time (*time quantum*), usually 10-100 milliseconds
 - After quantum expires, the process is preempted and added to the end of the ready queue.
 - n processes in ready queue and time quantum is $q \Rightarrow$
 - » Each process gets $1/n$ of the CPU time
 - » In chunks of at most q time units
 - » **No process waits more than $(n-1)q$ time units**

RR Scheduling (Cont.)

- Performance
 - q large \Rightarrow FCFS
 - q small \Rightarrow Interleaved
 - q must be large with respect to context switch, otherwise overhead is too high (all overhead)

Example of RR with Time Quantum = 20

- Example:

<u>Process</u>	<u>Burst Time</u>
P_1	53
P_2	8
P_3	68
P_4	24

- The Gantt chart is:

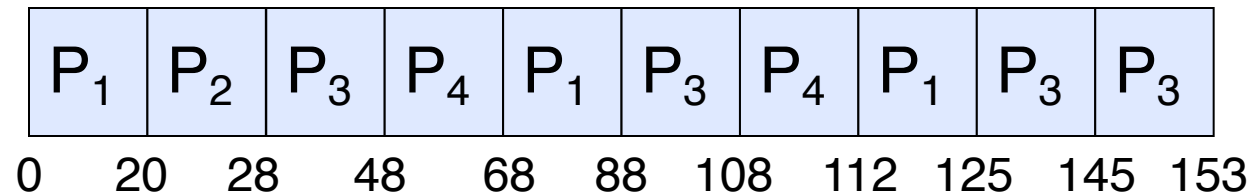

- Waiting time for

$$P_1 = (68 - 20) + (112 - 88) = 72$$

$$P_2 = (20 - 0) = 20$$

$$P_3 = (28 - 0) + (88 - 48) + (125 - 108) = 85$$

$$P_4 = (48 - 0) + (108 - 68) = 88$$

- Average waiting time = $(72 + 20 + 85 + 88) / 4 = 66\frac{1}{4}$

- Average completion time = $(125 + 28 + 153 + 112) / 4 = 104\frac{1}{2}$

- Thus, Round-Robin Pros and Cons:

- Better for short jobs, Fair (+)

- Context-switching time adds up for long jobs (-)

Group Discussion

- Topic: FCFS and RR
 - Is RR always better than FCFS in terms of average completion time?
 - Does a smaller quantum in RR always lead to a better average completion time?
- Discuss in groups of two to three students
 - Each group chooses a leader to summarize the discussion
 - In your group discussion, please do not dominate the discussion, and give everyone a chance to speak

Decrease Completion Time

- T_1 : Burst Length 10
- T_2 : Burst Length 1

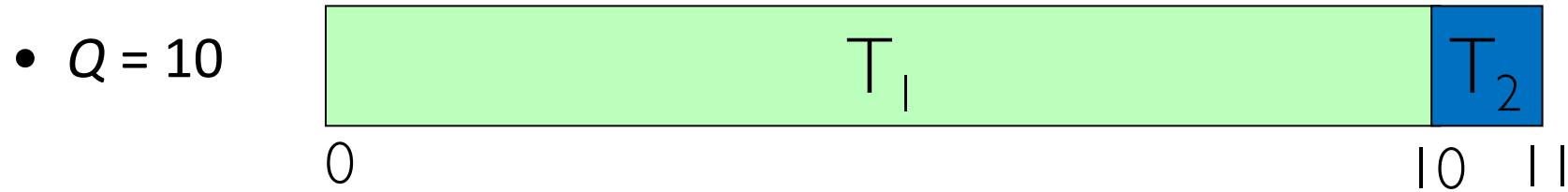

– Average Completion Time = $(10 + 11)/2 = 10.5$

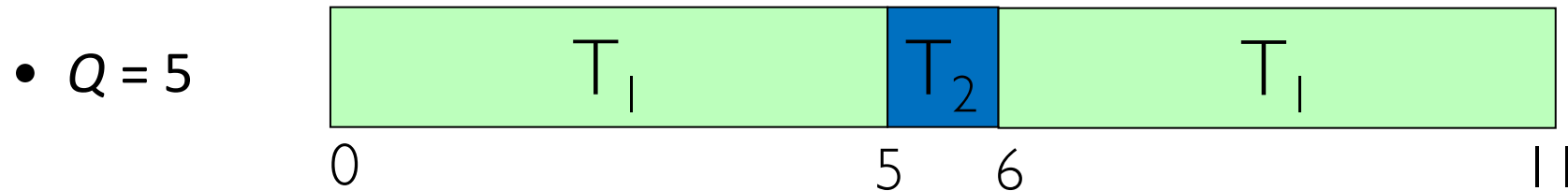

– Average Completion Time = $(6 + 11)/2 = 8.5$

Same Completion Time

- T_1 : Burst Length 1
- T_2 : Burst Length 1

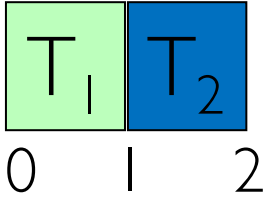
- $Q = 10$ 

– Average Completion Time = $(1 + 2)/2 = 1.5$

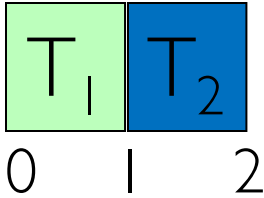
- $Q = 1$ 

– Average Completion Time = $(1 + 2)/2 = 1.5$

Increase Completion Time

- T_1 : Burst Length 1
- T_2 : Burst Length 1

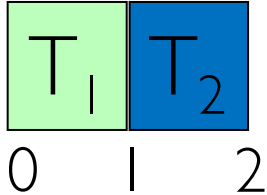
- $Q = 1$ 

– Average Completion Time = $(1 + 2)/2 = 1.5$

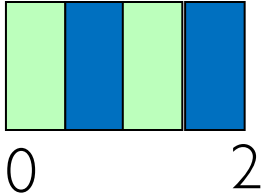
- $Q = 0.5$ 

– Average Completion Time = $(1.5 + 2)/2 = 1.75$

How to Implement RR in the Kernel?

- FIFO Queue, as in FCFS
- But preempt job after quantum expires, and send it to the back of the queue
 - How? Timer interrupt!
 - And, of course, careful synchronization

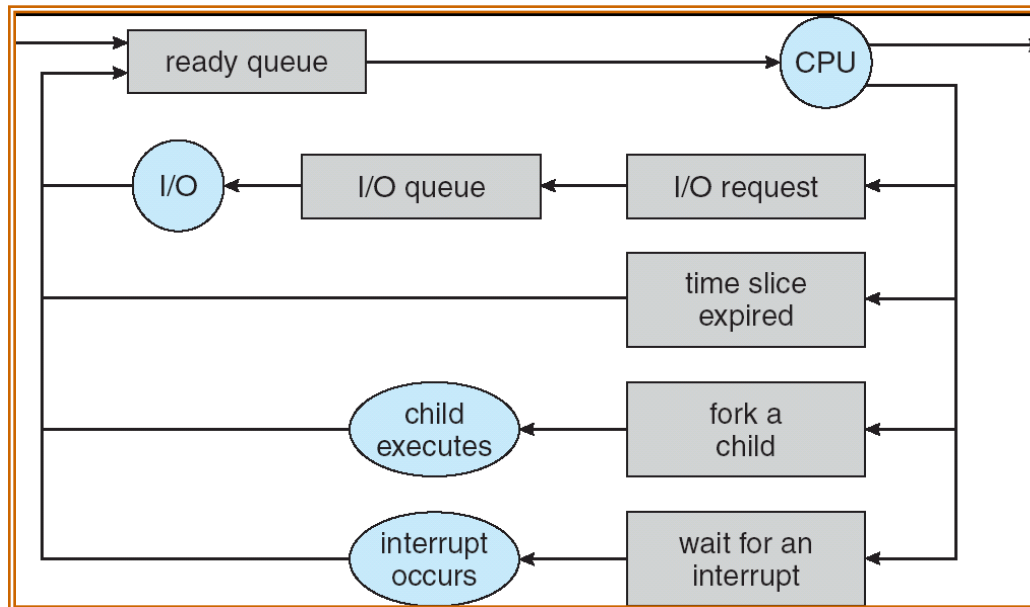

Round-Robin Discussion

- How do you choose time slice?
 - What if too big?
 - » Waiting time suffers
 - What if infinite (∞)?
 - » Get back FIFO
 - What if time slice too small?
 - » Throughput suffers!
- Actual choices of time slice:
 - Initially, UNIX time slice one second:
 - » Worked ok when UNIX was used by one or two people.
 - » What if three compilations going on? 3 seconds to echo each keystroke!
 - Need to balance short-job performance and long-job throughput
 - » Typical time slice today is between **10ms – 100ms**

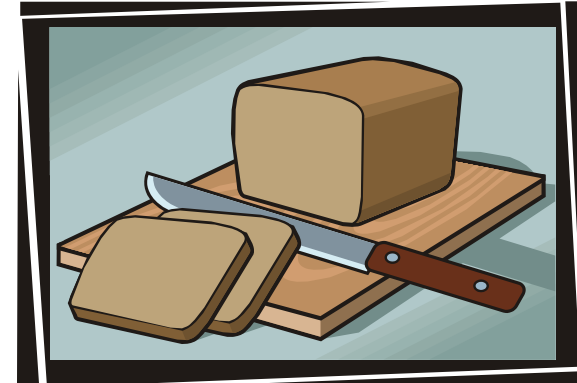

Comparisons between FCFS and Round Robin

- Assuming zero-cost context-switching time, is RR always better than FCFS?
- Simple example: 10 jobs, each take 100s of CPU time
RR scheduler quantum of 1s
All jobs start at the same time

- Completion Times:

Job #	FIFO	RR
1	100	991
2	200	992
...
9	900	999
10	1000	1000

- Both RR and FCFS finish at the same time
- Average completion time is much worse under RR!
 - » Bad when all jobs same length
- Also: Cache state must be shared between all jobs with RR but can be devoted to each job with FIFO
 - Total time for RR longer even for zero-cost switch!

Earlier Example with Different Time Quantum

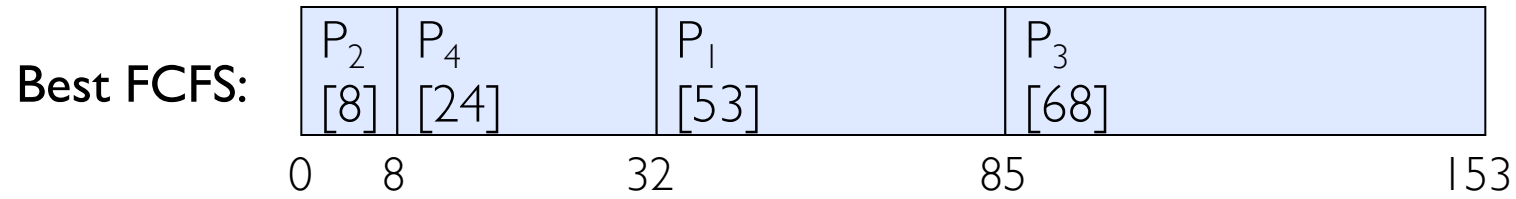

	Quantum	P ₁	P ₂	P ₃	P ₄	Average
Wait Time	Best FCFS	32	0	85	8	31¼
	Q = 1	84	22	85	57	62
	Q = 5	82	20	85	58	61¼
	Q = 8	80	8	85	56	57¼
	Q = 10	82	10	85	68	61¼
	Q = 20	72	20	85	88	66¼
	Worst FCFS	68	145	0	121	83½
Completion Time	Best FCFS	85	8	153	32	69½
	Q = 1	137	30	153	81	100½
	Q = 5	135	28	153	82	99½
	Q = 8	133	16	153	80	95½
	Q = 10	135	18	153	92	99½
	Q = 20	125	28	153	112	104½
	Worst FCFS	121	153	68	145	121¾

Handling Differences in Importance: Strict Priority Scheduling

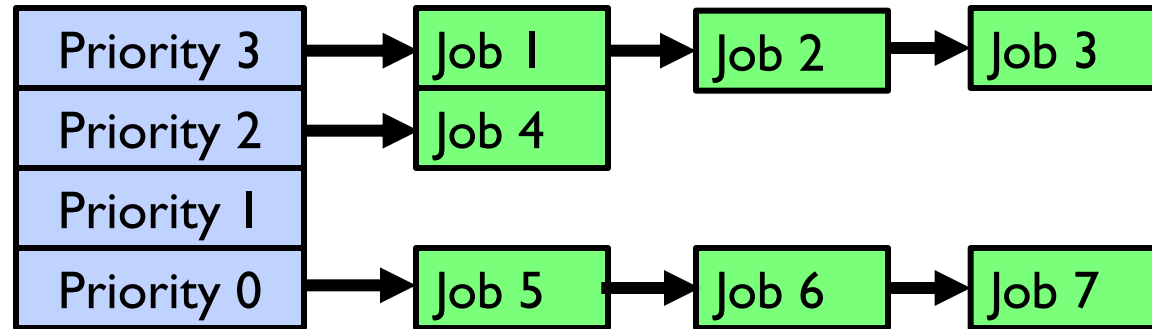

- Execution Plan
 - Always execute highest-priority runnable jobs to completion
 - Each queue can be processed in RR with some time-quantum
- Problems:
 - Starvation:
 - » Lower priority jobs don't get to run because higher priority jobs
 - Deadlock: Priority Inversion
 - » Happens when low priority task has lock needed by high-priority task
 - » Usually involves third, intermediate priority task preventing high-priority task from running
- How to fix problems?
 - Dynamic priorities: adjust base-level priority up or down based on heuristics about interactivity, locking, burst behavior, etc...

Scheduling Fairness

- What about fairness?
 - Strict fixed-priority scheduling between queues is unfair (run highest, then next, etc):
 - » long running jobs may never get CPU
 - » Urban legend: In Multics, shut down machine, found 10-year-old job ⇒
Ok, probably not...
 - Must give long-running jobs a fraction of the CPU even when there are shorter jobs to run
 - Tradeoff: fairness gained by hurting avg completion time!

Scheduling Fairness

- How to implement fairness?
 - Could give each queue some fraction of the CPU
 - » What if one long-running job and 100 short-running ones?
 - » Like express lanes in a supermarket—sometimes express lanes get so long, get better service by going into one of the other lines
 - Could increase priority of jobs that don't get service
 - » What is done in some variants of UNIX
 - » This is ad hoc—what rate should you increase priorities?
 - » And, as system gets overloaded, no job gets CPU time, so everyone increases in priority⇒Interactive jobs suffer

What if we Knew the Future?

- Could we always mirror best FCFS?
- Shortest Job First (SJF):
 - Run whatever job has least amount of computation to do
 - Sometimes called “Shortest Time to Completion First” (STCF)
- Shortest Remaining Time First (SRTF):
 - Preemptive version of SJF: if job arrives and has a shorter time to completion than the remaining time on the current job, immediately preempt CPU
 - Sometimes called “Shortest Remaining Time to Completion First” (SRTCF)
- These can be applied to whole program or current CPU burst
 - Idea is to get short jobs out of the system
 - Big effect on short jobs, only small effect on long ones
 - Result is better average completion time



Discussion

- SJF/SRTF are the best you can do at minimizing average completion time
 - Provably optimal (SJF among non-preemptive, SRTF among preemptive)
 - Since SRTF is always at least as good as SJF, focus on SRTF
- Comparison of SRTF with FCFS
 - What if all jobs the same length?
 - » SRTF becomes the same as FCFS (i.e. FCFS is best can do if all jobs the same length)
 - What if jobs have varying length?
 - » SRTF: short jobs not stuck behind long ones

Example to illustrate benefits of SRTF

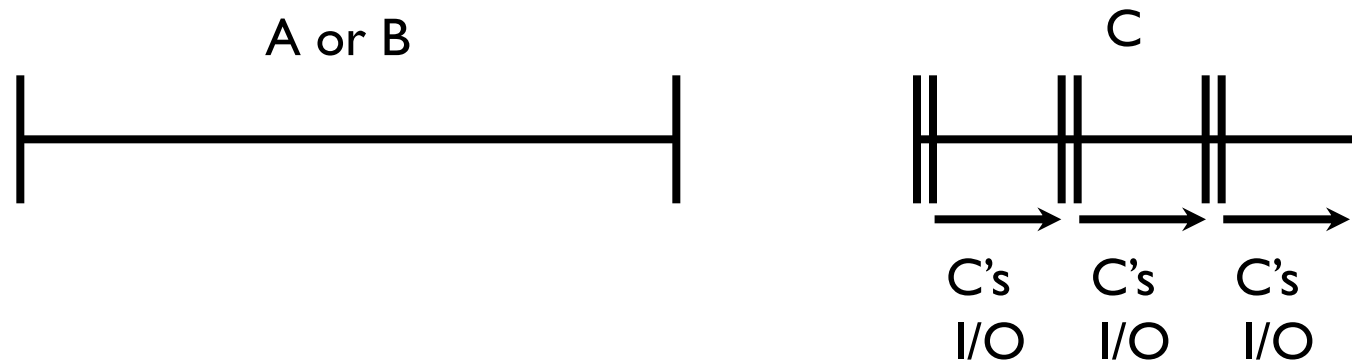

- Three jobs:
 - A, B: both CPU bound, run for week
 - C: I/O bound, loop 1ms CPU, 9ms disk I/O
 - If only one at a time, C uses 90% of the disk, A or B could use 100% of the CPU
- With FCFS:
 - Once A or B get in, keep CPU for two weeks
- What about RR or SRTF?
 - Easier to see with a timeline

SRTF Example continued:

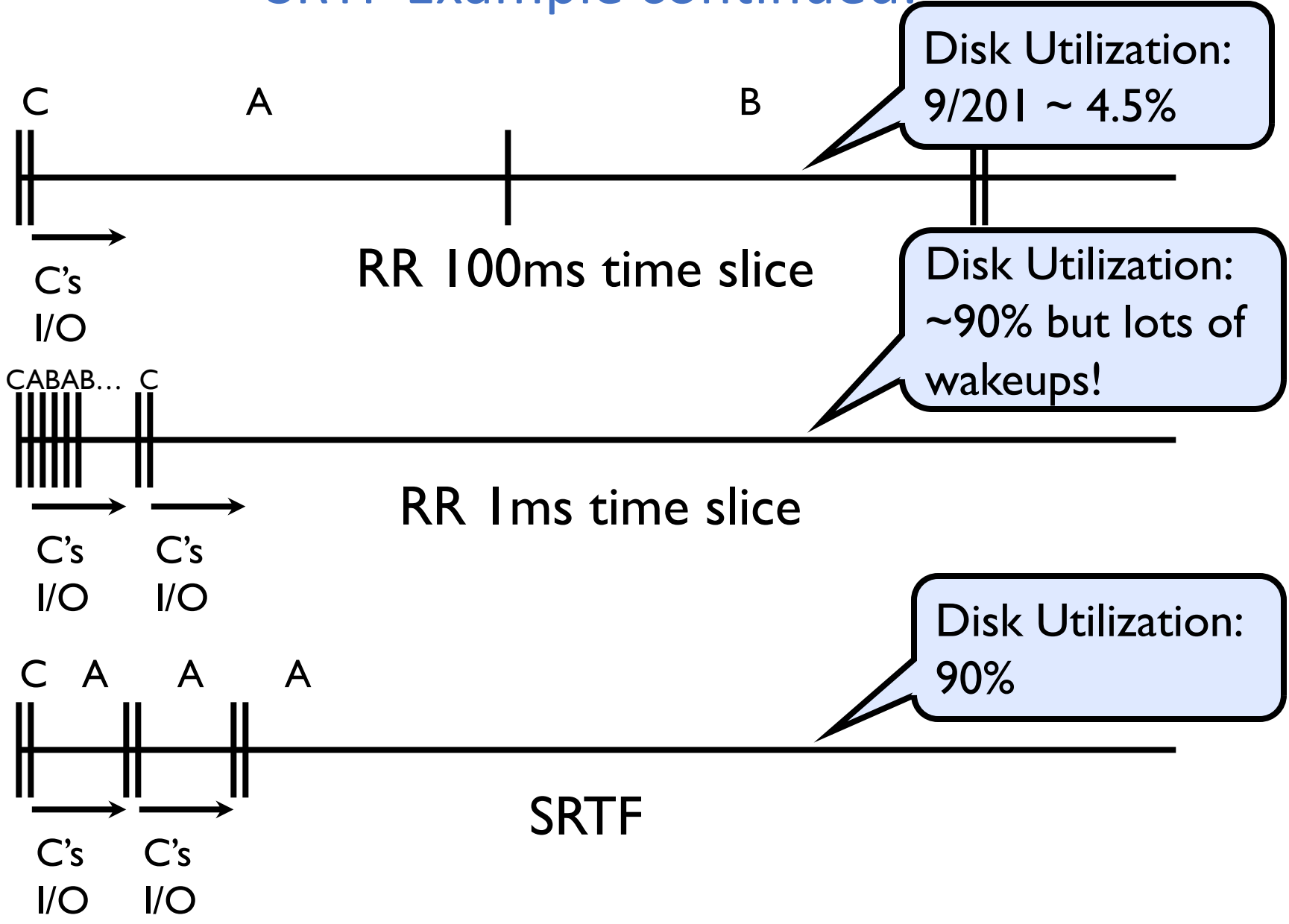

SRTF Further discussion

- Starvation
 - SRTF can lead to starvation if many small jobs!
 - Large jobs never get to run
- Somehow need to predict future
 - How can we do this?
 - Some systems ask the user
 - » When you submit a job, have to say how long it will take
 - » To stop cheating, system kills job if takes too long
 - But: hard to predict job's runtime even for non-malicious users
- Bottom line, can't really know how long job will take
 - However, can use SRTF as a yardstick for measuring other policies
 - Optimal, so can't do any better
- SRTF Pros & Cons
 - Optimal (average completion time) (+)
 - Hard to predict future (-)
 - Unfair (-)



Predicting the Length of the Next CPU Burst

- **Adaptive:** Changing policy based on past behavior
 - CPU scheduling, in virtual memory, in file systems, etc
 - Works because programs have predictable behavior
 - » If program was I/O bound in past, likely in future
 - » If computer behavior were random, wouldn't help
- Example: SRTF with estimated burst length
 - Use an estimator function on previous bursts:
Let $t_{n-1}, t_{n-2}, t_{n-3}$, etc. be previous CPU burst lengths.
Estimate next burst $\tau_n = f(t_{n-1}, t_{n-2}, t_{n-3}, \dots)$
 - Function f could be one of many different time series estimation schemes (Kalman filters, etc)
 - For instance,

exponential averaging

$$\tau_n = \alpha t_{n-1} + (1-\alpha)\tau_{n-1}$$

with $(0 < \alpha \leq 1)$

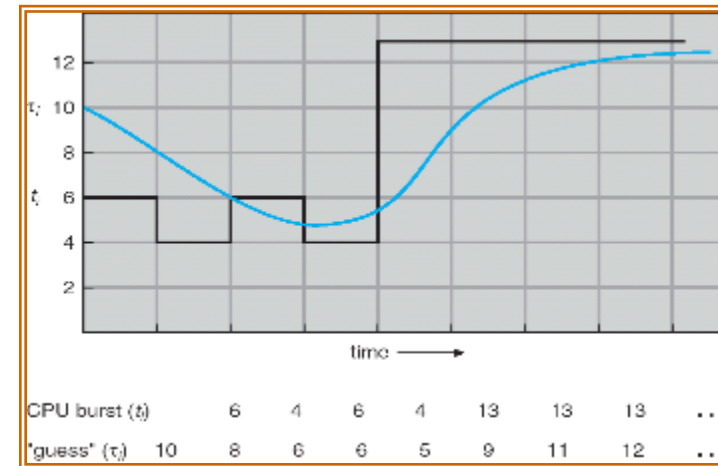

Lottery Scheduling

- Yet another alternative: Lottery Scheduling
 - Give each job some number of lottery tickets
 - On each time slice, randomly pick a winning ticket
 - On average, CPU time is proportional to number of tickets given to each job
- How to assign tickets?
 - To approximate SRTF, short running jobs get more, long running jobs get fewer
 - To avoid starvation, every job gets at least one ticket (everyone makes progress)
- Advantage over strict priority scheduling: behaves gracefully as load changes
 - Adding or deleting a job affects all jobs proportionally, independent of how many tickets each job possesses



Lottery Scheduling Example (Cont.)

- Lottery Scheduling Example

- Assume short jobs get 10 tickets, long jobs get 1 ticket

# short jobs/ # long jobs	% of CPU each short jobs gets	% of CPU each long jobs gets
1/1	91%	9%
0/2	N/A	50%
2/0	50%	N/A
10/1	9.9%	0.99%
1/10	50%	5%

- What if too many short jobs to give reasonable completion time?
 - » If load average is 100, hard to make progress
 - » One approach: log some user out

Multi-Level Feedback Scheduling

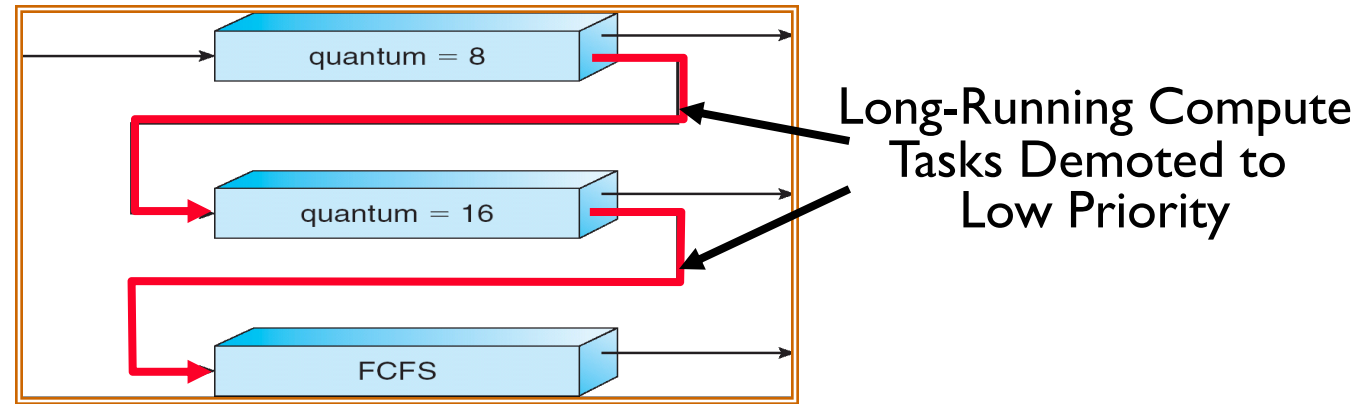

- Another method for exploiting past behavior (first use in CTSS)
 - Multiple queues, each with different priority
 - » Higher priority queues often considered “foreground” tasks
 - Each queue has its own scheduling algorithm
 - » e.g. foreground – RR, background – FCFS
 - » Sometimes multiple RR priorities with quantum increasing exponentially (highest:1ms, next: 2ms, next: 4ms, etc)
- Adjust each job’s priority as follows (details vary)
 - Job starts in highest priority queue
 - If timeout expires, drop one level
 - If timeout doesn’t expire, push up one level (or to top)

Conclusion

- **Round-Robin Scheduling:**
 - Give each thread a small amount of CPU time when it executes; cycle between all ready threads
 - Pros: Better for short jobs
- **Shortest Job First (SJF)/Shortest Remaining Time First (SRTF):**
 - Run whatever job has the least amount of computation to do/least remaining amount of computation to do
 - Pros: Optimal (average completion time)
 - Cons: Hard to predict future, Unfair
- **Lottery Scheduling:**
 - Give each thread a priority-dependent number of tokens (short tasks \Rightarrow more tokens)
- **Multi-Level Feedback Scheduling:**
 - Multiple queues of different priorities and scheduling algorithms
 - Automatic promotion/demotion of process priority in order to approximate SJF/SRTF